

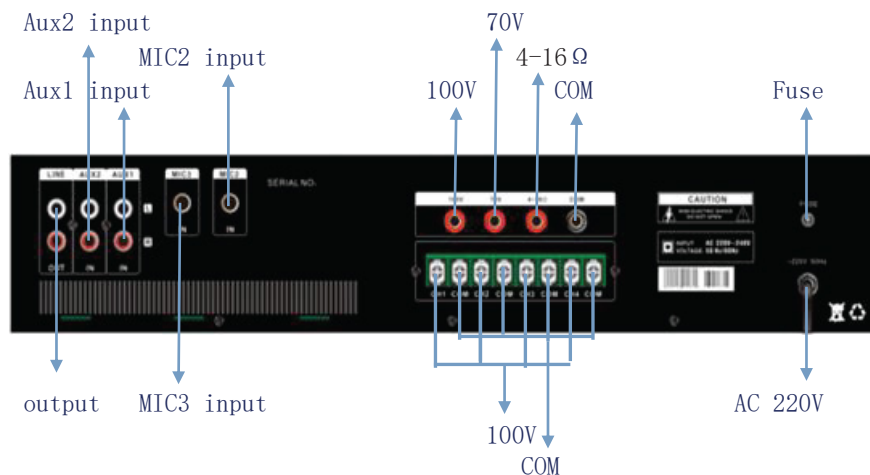

AYZO

SECURING BUSINESS SECURING LIVES

AMPLIFIER A-BT-4Z-680W



Model:	A-BT-4Z-680W
Line voltage:	70-100V
Impedance:	4-16Ω
Rated power output:	680W
Weight:(kg)	18.5
Gross weight:(kg)	19.78
Dimension:	485*395*90mm
Frequency Responses:	60Hz-15KHz
Power Supply:	110V/60Hz or 230V/50Hz
Protection:	AC fuse,short-circuit and high temperature

Function:

1. Transformer isolated 100V, 70V and 4-16 Ohms speaker output, balanced, no grounding with 100V and 0db input.
2. 5 LED indicators for status display.
3. XLR socket and 6.35 mm jack for amplifier link.
4. Output circuit shorting protection & display, Short-circuit warning and protection, over-heat warning.
5. Series amplifiers of high output power available.